

Three-port seat valves PN16, with male thread

VXG44...



Three-port seat valves with male thread, PN16

- Bronze Rg5
- DN15 ... DN40 mm (1/2" ... 1 1/2")
- k_{vs} 0.25 ... 25 m³/h
- Stroke 5.5 mm
- Manual adjustment by means of mounted knob
- Can be equipped with SQS35..., SQS65... or SQS85... actuators
- Fittings can be delivered separately

Application

In small and medium-sized heating, ventilating and air conditioning systems as a **control valve** for "mixing" and "diverting" functions. **For closed circuits only.**

Media

Cooling water	+2 ... +120 °C
Chilled water	
Low temperature hot water	
Water with anti-freeze	

Type summary

Type	DN [mm]	k_{vs} [m ³ /h]	S_v	$\Delta p_{vmax.}$	
				mixing [kPa]	diverting ¹⁾ [kPa]
VXG44.15-0.25	15	0.25	> 50	400	100
VXG44.15-0.4		0.4			
VXG44.15-0.63		0.63			
VXG44.15-1		1			
VXG44.15-1.6	20	1.6	> 100	300	75
VXG44.15-2.5		2.5			
VXG44.15-4		4			
VXG44.20-6.3		6.3			
VXG44.25-10	25	10	> 100	200	50
VXG44.32-16	32	16			
VXG44.40-25	40	25			
VXG44.40-25	40	25			

1) If noise is permitted, the same values apply as for mixing

DN = Nominal diameter

k_{vs} = Nominal flow value as per VDI2173

S_v = Rangeability as per VDI2173

$\Delta p_{vmax.}$ = Max. permissible differential pressure across the control path (A – AB = mixing or AB – A = diverting) of the valve valid for the entire stroke range

Ordering

When ordering, please specify the quantity, product name and type code.

Example: **1 Three-port valve VXG44.25-10**

The fittings must be ordered separately.

Delivery

The valve, actuator and possible fittings are packed and supplied separately.

Equipment combinations

Valves Type	H ₁₀₀ [mm]	Actuators ¹⁾ SQS35..., SQS65..., SQS85...		Fittings Type	
		mixing Δp _{max} [kPa]	diverting ²⁾		
VXG44.15-0.25 VXG44.15-0.4 VXG44.15-0.63	5.5	400	100	ALG15	
VXG44.15-1 VXG44.15-1.6			100		
VXG44.15-2.5 VXG44.15-4					
VXG44.20-6.3 VXG44.25-10 VXG44.32-16 VXG44.40-25			300 200 100		75 50 35
Data sheet N4573					

- 1) Actuators available for delivery:
- AC 230 V with 3-position signal
 - AC 24 V with 3-position signal
 - AC 24 V with DC 0...10 V or DC 2...10 V proportional pos. signal

2) If noise is permitted, the same values apply as for mixing

H₁₀₀ = 100 % stroke of the valve and the actuator

Δp_{max} = Max. permissible differential pressure across the control path (A – AB = mixing or AB – A = diverting) of the valve across the entire actuating range of the motorised valve

Mechanical design

Valve cross-section

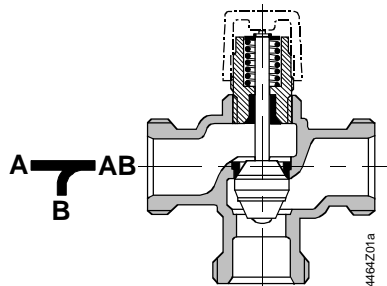

- Guided parabolic plug which is integrated in the valve stem.
- The seat is fitted in the through-port and attached directly to the valve body in the bypass.
- From DN25, the seat in the through-port in the valve body and attached to the ring in the bypass.

Disposal

The various material types used require that you disassemble the unit and sort the components prior to disposal.

Sizing

Flow diagram

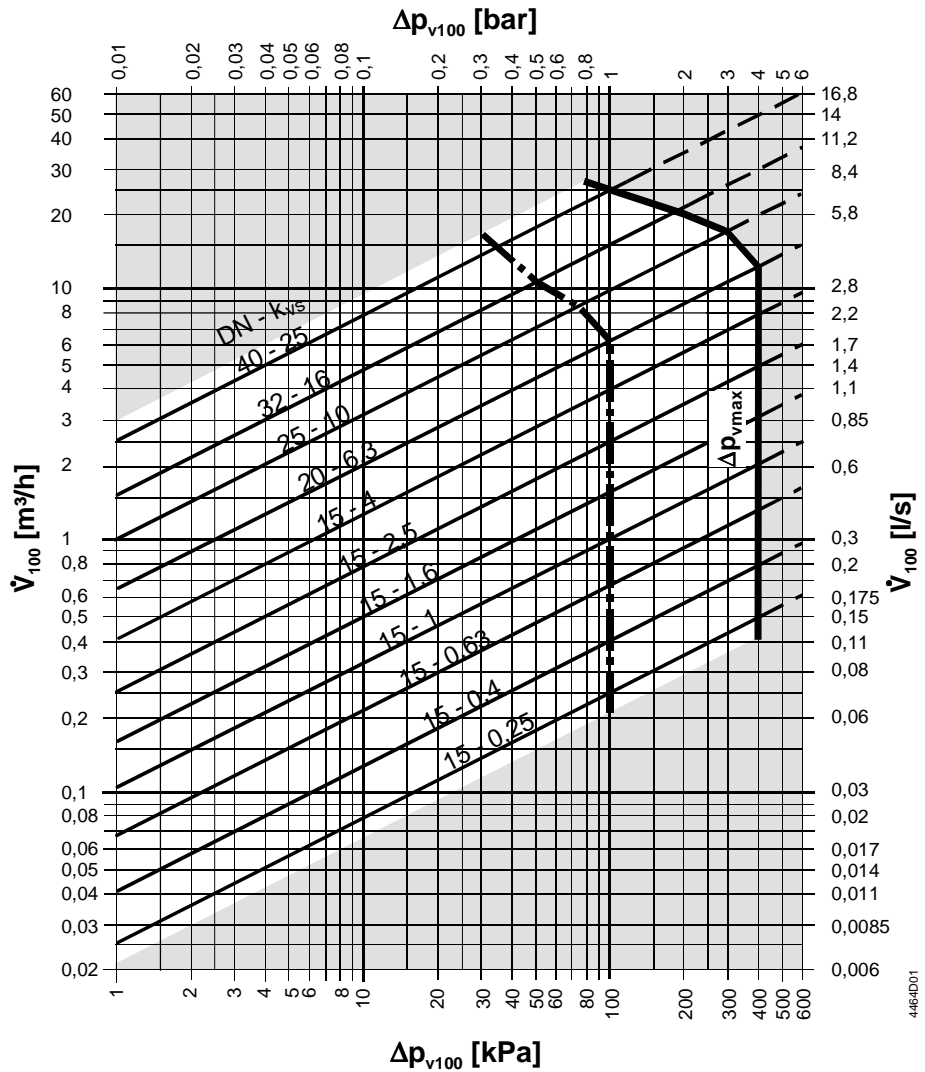

100 kPa = 1 bar \approx 10 mWG

1 m^3/h = 0.278 kg/s water at 20 °C

— = Δp_{vmax} = Max. permissible differential pressure across the **mixing valve's A – AB control path** (actuator) valid for the entire stroke range

- - - = Δp_{vmax} = Max. permissible differential pressure across the **diverting valve's AB – A control path** (actuator) valid for the entire stroke range

Δp_{v100} = Pressure difference across the fully opened valve (actuator) across the control path (A – AB = mixing or AB – A = diverting) at flow \dot{V}_{100}

\dot{V}_{100} = Flow in m^3/h

Valve flow characteristic

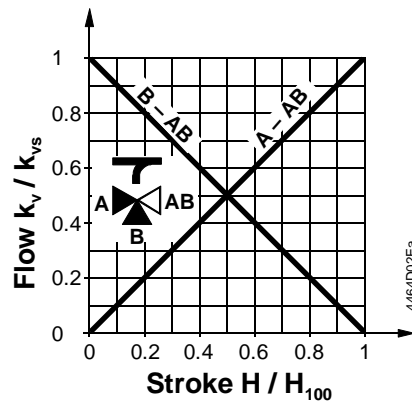

Valve flow characteristic:

- Through-port: linear as per VDI /VDE2173
- Bypass: linear as per VDI /VDE2173

Mixing:

Flow from port A and port B to port AB

Diverting:

Flow from port AB to port A and port B

Port A = variable flow

Port B = Bypass (variable flow)

Port AB = constant flow

Use the three-port valve primarily as a mixing valve

Notes

Engineering

Water quality requirements as per VDI2035.

Note We recommend installing a strainer upstream of the valve to ensure long-term functional safety.

Mounting

Both valve and actuator can easily be assembled at the mounting location. Neither special tools nor adjustments are required.
The valve is supplied with mounting instructions.

Mounting positions

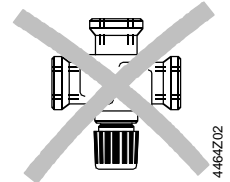
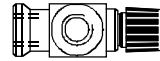
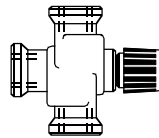
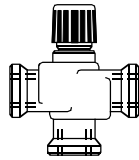

Permissible

Not permissible

Direction of flow

When mounting, pay attention to the valve's flow direction symbol:

Mixing from A / B to AB



Diverting from AB to A / B

Commissioning

Commission the valve using the mounted manual adjustment button or a correctly mounted actuator.

Stem retracts: Through-port opens, bypass closes
Stem extends: Through-port closes, bypass opens

Service



For actuator service work: Turn off the pump and the operating voltage, close the shutoff valves, depressurize the pipes and allow them to cool down. Disconnect the electrical connections, where required, from the terminals. Recommission the valve using the mounted manual adjustment button or a correctly mounted actuator.

Stem sealing gland

The stem sealing gland cannot be exchanged. In the case of leakage, the entire valve must be replaced, whereby the information provided in "Service" must be observed. Contact your local office or branch.

Warranty

The use of third-party actuators expressly voids any warranty claims.

The technical data Δp_{max} , Δp_s , leakage rate, noise level and life apply only when used together with the Landis & Staefa actuators as listed in "Type summary".

Technical data

Function data

PN class	PN16
Valve flow characteristic	
Through-port	linear as per VDI /VDE2173
Bypass	linear as per VDI /VDE2173
Leakage rate	
Through-port	0 ... 0.02 % of k_{VS} value, VDI /VDE2174
Bypass	0 ... 0.02 % of k_{VS} value, VDI /VDE2174
Permissible pressure	1600 kPa (16 bar), ISO7268 / EN1333
Working pressure	DIN4747 / DIN3158 in the range of +2 ... +120 °C
Threaded connection	
Valve	G...B as per ISO228/1
Fittings	Rp... as per ISO7/1
Stroke	5.5 mm
Weight	see "Dimensions" (table)

Materials

Valve body	bronze G-CuSn5ZnBb (Rg5) as per DIN1705
Seat	stainless steel, bronze Rg5 and brass
Seat in bypass	Bronze Rg5 or brass
Plug	stainless steel or brass
Stem	stainless steel
Gland materials	EPDM-O rings
Fittings ALG...	black malleable cast iron

Dimensions

All dimensions in mm

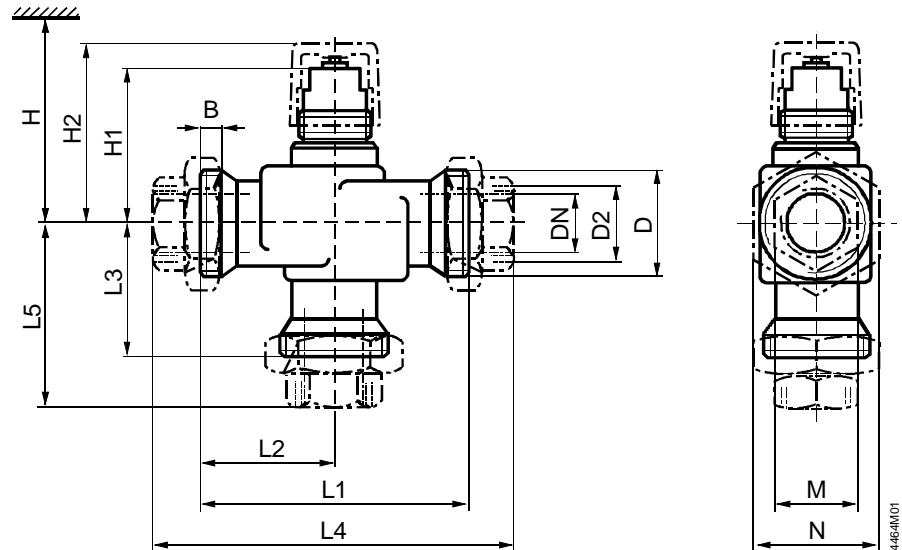

DN [mm]	B	D	D2	H1	H2	L1	L2	L3	L4	L5	M	N	Weight without fittings [kg]
15	8.5	G1B	Rp $\frac{1}{2}$	53	63	100	50	50	148	74	25	41	0.50
20	9	G1 $\frac{1}{4}$ B	Rp $\frac{3}{4}$	68	78				150	75	32	50	0.85
25	11	G1 $\frac{1}{2}$ B	Rp1	71	81	105	52.5	52.5	160	80	38	55	1.20
32		G2B	Rp1 $\frac{1}{4}$	77.5	87.5				170	85	47	70	1.60
40		G2 $\frac{1}{4}$ B	Rp1 $\frac{1}{2}$	80.5	90.5	130	65	65	198	99	53	75	2.30

DN [mm]	H SQS35..., SQS65..., SQS85...
15	> 364
20	> 379
25	> 382
32	> 389
40	> 392

DN = Nominal diameter

H = Total actuator height plus minimum distance to wall or ceiling for mounting, connection, operation, service, etc.

H1 = Dimension from the pipe centre to install of the actuator

H2 = Pipe centre to upper edge of manual adjustment button