



Heating Controller

with or without d.h.w. heating

RVP201...

RVP211...

Heating controller for use in residential or smaller non-residential buildings that have their own heat generating plant.

Weather-compensated flow temperature control with or without room temperature influence or room temperature control.

Control of three-position or two-position actuators or direct control of burner, control of circulating pump, control of d.h.w. heating.

Analog operating elements for the end-user. Operating voltage AC 230 V.

Use

- Types of houses and buildings:
 - Small multi-family houses
 - Single-family houses or holiday houses
 - Smaller non-residential buildings
- Types of plant:
 - Heating zones with their own heat generating equipment and own d.h.w. heating
- Types of heating systems:
 - Radiator, convector, underfloor and ceiling heating systems, as well as radiant panels

Functions

Key functions

The RVP201/211 heating controller has been designed for use with the following types of control systems and plants:

- Flow temperature control via a motorized three-position mixing valve
- Flow temperature control via a motorized two-position mixing valve
- Boiler temperature control via single-stage burner and a circulating pump

With all three types of plant, one of the following control modes can be used:







- Weather-compensated
- Weather-compensated with room temperature influence
- Room temperature-compensated

Other functions

- Room temperature-dependent quick setback and boost heating
- ECO automatic energy saver for load-dependent switching of heating
- D.h.w. heating with choice of priority
- Frost protection for the plant and the space in all operating modes
- Remote control with room unit

Note: some of the above functions require appropriate control equipment (sensors, etc.)

Operating modes

-  *Automatic operation normal / protection mode*
Automatic changeover between normal temperature and protection mode according to the 24-hour or weekly program, ECO automatic energy saver, d.h.w. heating
-  *Automatic operation normal / reduced*
Automatic changeover between normal and reduced temperature according to the 24-hour or weekly program, ECO automatic energy saver, d.h.w. heating
-  *Setback mode*
Continuous heating to the reduced temperature, with ECO automatic energy saver, d.h.w. heating
-  *Normal mode*
Continuous heating to the normal temperature, no ECO automatic energy saver, d.h.w. heating
-  *Protection mode*
Frost protection is ensured
-  *Manual operation*
Control switched off, d.h.w. charging pump and heating circuit pump running
-  *Automatic d.h.w. heating*
Heating control in protection mode

Note: d.h.w. heating is provided only by the RVP211

Type summary

<i>Type of unit</i>	<i>Type ref.</i>
Heating controller without time switch	RVP201.0
Heating controller with analog 24-hour time switch	RVP201.1
Heating controller without time switch, with d.h.w. heating	RVP211.0
Heating controller with analog 24-hour time switch, with d.h.w. heating	RVP211.1
Analog 24-hour time switch	AUZ3.1
Analog weekly time switch	AUZ3.7
Digital weekly time switch	AUD3

Equipment combinations

Suitable sensors and room units

- Flow, boiler and d.h.w. temperature: all sensors with LG-Ni 1000 sensing element, such as
 - Strap-on temperature sensor QAD22
 - Immersion temperature sensor QAE212... and QAP21.3
- Outside temperature (the controller automatically identifies the type of sensor used):
 - Outside sensor QAC22 (LG-Ni 1000 sensing element)
 - Outside sensor QAC32 (NTC 575 sensing element)
- Room temperature; there are two types of room units available:



Room unit QAW70
with room sensor, time switch, setpoint adjustment and room temperature readjustment (setting knob)



Room unit QAW50,
with room sensor, room temperature readjustment (setting knob)

Suitable actuators

- All electric or electro-hydraulic actuators for three-position control from Siemens can be used:
 - Operating voltage AC 24...230 V
 - Maximum running time 6 minutes (recommended: 2 to 3 minutes)
- All electro-thermal actuators for two-position control:
 - Operating voltage AC 24...230 V
 - Running time 8 to 16 minutes

Ordering

- When ordering, please give type reference according to "Type summary"
- If a controller with a weekly time switch is required, the type RVP201.0 or RVP211.0 **plus** the required time switch (**AUZ3.7** or **AUD3**) must be ordered
- Sensors, room unit, actuator and valve must be ordered as separate items

Product documentation

Type of documentation	Document no.	Part no.
Basic Documentation	P2464	–
Installation Instructions (languages: de, en, fr, nl, sv, fi, da, it, es, el)	G2464	74 319 0614 0
Operating Instructions (languages: de, en, fr, nl, sv, fi, da, it, es, el)	B2464	74 319 0613 0
CE Declaration of Conformity	T2464	–
Environmental Declaration	E2464	–

Technical design

Heating curve chart

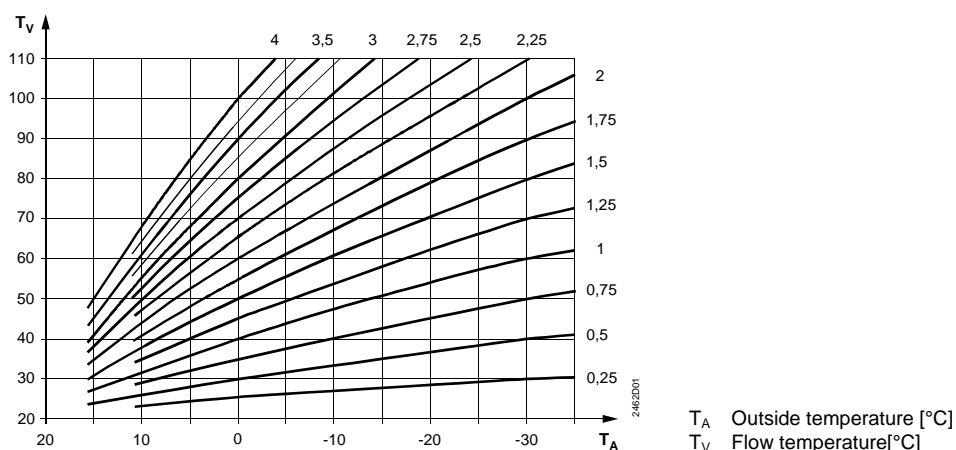

Compensating variables

- Weather-compensated control: the setpoint of the flow or boiler temperature is continuously shifted in function of the outside temperature (via the outside sensor). Assignment of the flow temperature to the actual outside temperature is made via the heating curve. Its slope is adjustable

- Weather-compensated control with room temperature influence: the setpoint of the flow or boiler temperature is continuously shifted in function of the outside temperature (via the outside sensor) and, in addition, in function of the setpoint / actual value deviation of the room temperature
Room temperature authority is adjustable (range 0...100 %); guide value is 50 %
- Room temperature-compensated control: the setpoint of the flow or boiler temperature is continuously shifted in function of the setpoint / actual value deviation of the room temperature

With both types of weather-compensated control, the composite outside temperature is used as the compensating variable. It is generated from the actual and the attenuated outside temperature. Compared to the actual outside temperature it is attenuated and delayed.

Flow temperature control

- Three-position control: the flow temperature is controlled continuously with no offset via a seat or slipper valve driven by an electric or electro-hydraulic actuator
- Two-position control: the flow temperature is controlled via a seat or slipper valve driven by an electro-thermal actuator. The switching differential is 1 K
Maximum limitation of the flow temperature can be provided in the range 10...100 °C. This function can be deactivated.

Boiler temperature control

The boiler temperature is controlled by a single-stage burner which is switched on and off. The burner's minimum on time is four minutes. The switching differential is adjustable in the range 1...20 K.
Maximum limitation of the boiler temperature can be provided in the range 10...100 °C. This function can be deactivated.
If the boiler temperature falls below 5 °C, the burner will be switched on to maintain a minimum boiler temperature.
When there is no demand for heat and during quick setback, the boiler will be switched off.

D.h.w. heating

- In the case of flow temperature control with a mixing valve, d.h.w. heating is ensured with a charging pump
- With boiler temperature control, the d.h.w. is heated either with a charging pump or changeover valve

In the case of a charging pump, priority selection can be:

- Absolute priority: during d.h.w. heating, the heating circuit pump is locked
- No priority (parallel): heating circuit pump and d.h.w. charging pump operate at the same time

With underfloor heating systems and boiler operations, absolute priority must always be set. The temperature is measured with an immersion sensor LG-Ni 1000. If the sensor acquires a d.h.w. temperature below the setpoint, the charging pump or changeover valve will be activated. The excess flow temperature during charging is 16 K (fixed value) above the adjusted d.h.w. temperature setpoint.

The d.h.w. storage tank is protected against frost. If there is risk of frost, the d.h.w. temperature will not be allowed to fall below 5 °C.

The d.h.w. temperature can also be acquired by a thermostat. Charging takes place when the thermostat's contact closes. There is no protection against frost.

Note: a relay controlled by the thermostat (low voltage!) must be connected to terminals B3-M.

Frost protection for the plant

The heating circuit pump is activated to prevent freeze-ups in the plant. Frost protection can be provided with or without an outside sensor:

- With outside sensor:
 - Outside temperature ≤ 1.5 °C: the heating circuit pump will be switched on for 10 minutes at 6-hour intervals
 - Outside temperature ≤ -5 °C: the heating circuit pump runs continuously

- Without outside sensor:
 - Flow temperature ≤ 10 °C: the heating circuit pump will be switched on for 10 minutes at 6-hour intervals
 - Flow temperature ≤ 5 °C: the heating circuit pump runs continuously
- Frost protection for the plant can be deactivated, if required.

Frost protection for the building

Frost protection for the building acts as minimum room temperature limitation and protects the rooms from too low temperatures. It can be achieved with or without room unit, provided the heating curve slope is correctly set.

- Without room unit:
 - Attenuated outside temperature ≤ 5 °C: the control is switched on and the flow temperature is controlled such that a room temperature of 5 °C will be maintained
 - Attenuated outside temperature >6 °C: the control is switched off
- With room unit and quick setback active:
 - Room temperature ≤ 5 °C: the control is switched on and the flow temperature is controlled such that a room temperature of 5 °C will be maintained
 - Room temperature >6 °C: the control is switched off
- With room unit, without quick setback:
 - Same as without room unit

Frost protection for the building can be deactivated, if required.

Pump control

- Pump overrun: heating circuit pump and d.h.w. charging pump with six minutes overrun
- Pump kick: all pumps are periodically switched on for one minute

Boost heating

When changing from the reduced temperature or protection mode to the normal temperature, the room temperature setpoint is raised by 5 K. When the room temperature reaches a level which lies 0.25 K below the setpoint of the normal temperature, boost heating will be switched off.

Boost heating necessitates a room unit.

Quick setback

When changing from the normal temperature to the reduced temperature or protection mode, the heating will be shut down until the respective room temperature setpoint is reached.

Quick setback necessitates a room unit. This function can be deactivated, if required.

ECO automatic energy saver

The ECO automatic energy saver controls the heating depending on demand. It switches the heating off if permitted by outside temperature conditions while considering the actual, the attenuated and the composite outside temperature as well as the adjustable heating limit.

The ECO automatic energy saver necessitates an outside sensor. It can be deactivated, if required.

Temperature acquisition

- Flow and boiler temperature: with a LG-Ni 1000 sensor
- Outside temperature: with a LG-Ni 1000 or NTC 575 sensor; the controller identifies the type of sensor used
- Room temperature: with a room unit

Time switches for the heating program

The controller is equipped with a plug-in type time switch for entering a 24-hour or weekly heating program. Backup is ensured.

The following choices are available:

- Analog 24-hour time switch
 - Resolution of switching points: 15 minutes
 - Shortest on or off times: 15 minutes
- Analog weekly time switch
 - Resolution of switching points: one hour
 - Shortest on or off times: two hours
- Digital time switch

Any of these three time switches can also be fitted at a later time.

- Sensor cables must not be run parallel to mains carrying cable for loads such as actuator, pump, burner, etc. (safety class II to EN 60730)
- The maximum limitation of the boiler temperature may not be used as a safety function. For that purpose a thermostat or safety limiter must be connected at terminals L–F1/F4

Commissioning notes

- Setpoint adjustments:
 - Normal temperature (in °C room temperature)
 - Setback (in °C room temperature)
 - D.h.w. (only with the RVP211)
- Settings to be made by the heating engineer:
 - Slope of heating curve
 - Authority of room temperature
 - ECO heating limit
 - Maximum limitation of the flow or boiler temperature
 - Type of regulating unit (mixing valve or burner)
 - Type of control (three- or two-position)
 - Frost protection activated or deactivated
 - Priority of d.h.w. heating (only with the RVP211)

The controller is supplied complete with installation instructions and operating instructions.

Disposal



In terms of disposal, the RVP201/211 are classified as electronic scrap conforming to the European Directive 2002/96/EG (WEEE) and must not be disposed of as domestic waste. The relevant national legal requirements must be complied with and the units must be disposed of through the relevant channels. Local and currently valid legislation must be observed.

Warranty

When using the RVP201/211 together with third-party devices not specifically mentioned, correct functioning must be ensured by the user. In that case, Siemens will assume no responsibility for service and warranty.

Technical Data

Power supply	Rated operating voltage	AC 230 V (±10 %)
	Frequency	50 Hz
	Power consumption (no external load)	7 VA
	Supply line fusing	10 A
Output relays	Switching capacity	AC 24...230 V, AC 0.02...2 (2) A
	Rated current of ignition transformer	max.1 A (max. 30 s)
	Switch-on current of ignition transformer	max.10 A (max. 10 ms)
Permissible cable lengths to the sensors and the room unit	Copper cable 0.6 mm Ø	30 m
	Copper cable 0.5 mm ²	50 m
	Copper cable 1.0 mm ²	80 m
	Copper cable 1.5 mm ²	120 m

Connection terminals Screw terminals for wire section up to 2.5 mm²

Setting ranges

Setpoint of normal room temperature	20 ±0...8 °C
Setback for reduced room temperature	-12...0 K
Setpoint of d.h.w. temperature (only with the RVP211)	10...60 °C
Slope of heating curve	0.25...4
Max. limit of flow or boiler temperature	10...100 °C
ECO heating limit	-10...+8 K (referred to normal setpoint)
Authority of room temperature	0...100 %
Switching differential with two-position control	1...20 K

Backup of time switches

Analog time switches	12 hours
Digital weekly time switch	with backup battery

Standards

CE-conformance to

EMC directive	2004/108/EC
– Immunity	– EN 61000-6-1/2
– Emissions	– EN 61000-6-3/4
Low voltage directive	2006/95/EC
– Safety	– EN 60730-1 / EN 60730-2-9

Protective data

Safety class	II to EN 60730
Degree of protection (cover closed)	IP40 to EN 60529
Degree of contamination	2 to EN 60730

Dimensions refer to "Dimensions"

Weight Unit (net) 0.72 kg

Colors

Controller insert	Light grey RAL 7035
Terminal base	Pigeon blue RAL 5014

Environmental conditions

	<i>Operation</i> EN 60721-3-3	<i>Transport</i> EN 60721-3-2	<i>Storage</i> EN 60721-3-1
Climatic conditions	class 3K5	class 2K3	class 1K3
Temperature	0...+50 °C	-25...+70 °C	-20...+65 °C
Humidity	<95 % r.h. (non-condensing)	<95 % r.h.	<95 % r.h. (non-condensing)
Mechanical conditions	class 3M2	class 2M2	class 1M2
Use above sea level	max. 3000 m above sea level		

Connection diagrams

For low voltage

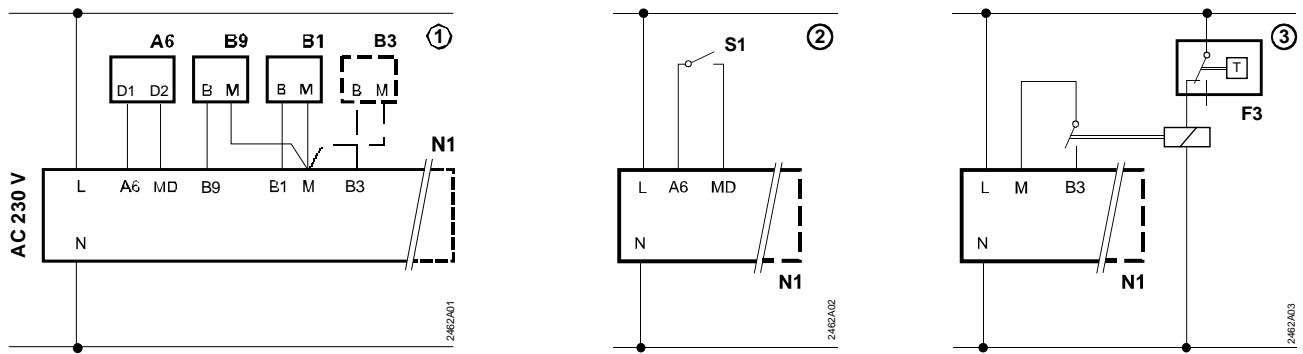

- ① = Measurement of d.h.w. temperature with sensor (only with the RVP211)
- ② = External switch for changeover of operating mode
- ③ = Measurement of d.h.w. temperature with a thermostat plus an intermediate relay (only with the RVP211)

For mains voltage

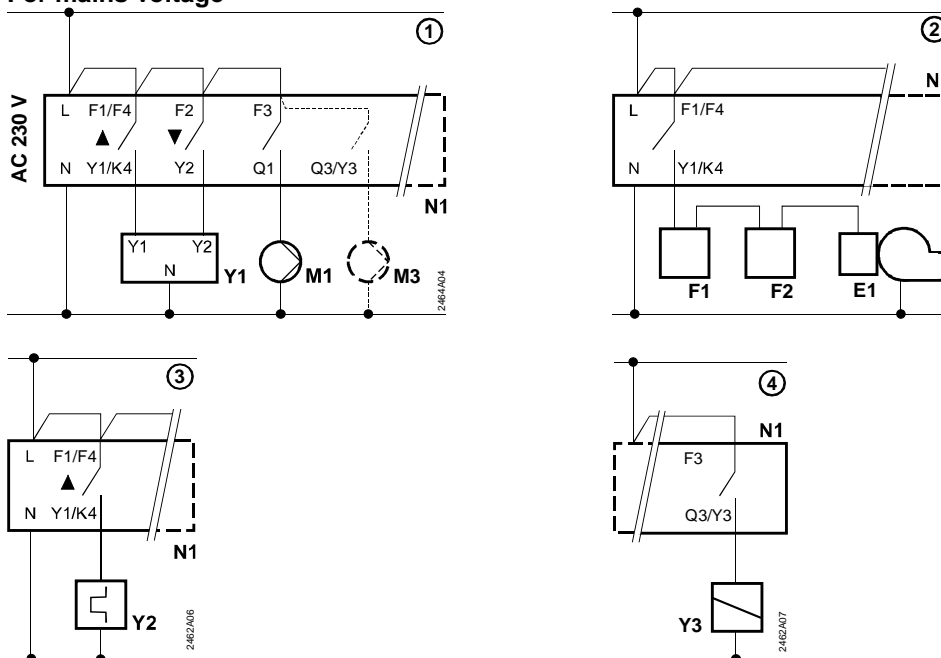

- ① = Connection of three-position actuator (flow temperature control), heating circuit pump and d.h.w. charging pump (d.h.w. charging pump only with the RVP211)
- ② = Connection of burner (boiler temperature control)
- ③ = Connection of two-position actuator (flow temperature control)
- ④ = Connection of actuator for changeover valve (only with the RVP211)

A6	Room unit	M1	Heating circuit pump
B1	Flow or boiler temperature sensor	M3	D.h.w. charging pump (only with the RVP211)
B3	D.h.w. temperature sensor (only with the RVP211)	N1	Controller RVP201/211
B9	Outside sensor	S1	External switch
E1	Burner	Y1	Three-position actuator
F1	Thermal reset limit thermostat	Y2	Two-position actuator
F2	Manual reset safety limit thermostat	Y3	Actuator for d.h.w. changeover valve (only with the RVP211)
F3	D.h.w. thermostat (only with the RVP211)		

Application examples

Example 1

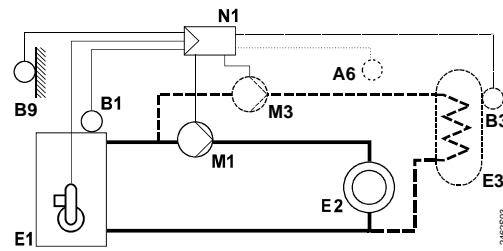

Boiler temperature control (two-position control, acting on the burner), d.h.w. heating with charging pump

Example 2

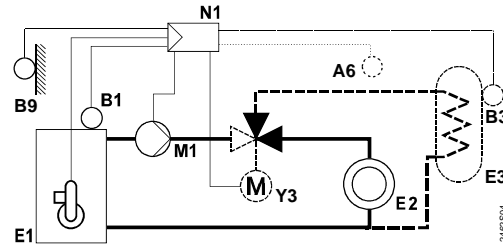

Boiler temperature control (two-position control, acting on the burner), d.h.w. heating with changeover valve

Example 3

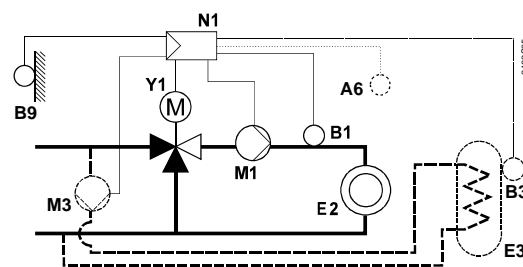

Flow temperature control (three- or two-position control, acting on the seat or slipper valve), d.h.w. heating with charging pump

A6	Room unit	E3	D.h.w. storage tank
B1	Boiler or flow temperature sensor	M1	Heating circuit pump
B3	D.h.w. temperature sensor	M3	D.h.w. charging pump
B9	Outside sensor	N1	Controller RVP201/211
E1	Boiler	Y1	Motorized three- or two-position mixing valve
E2	Load (room)	Y3	Motorized changeover valve

Dimensions

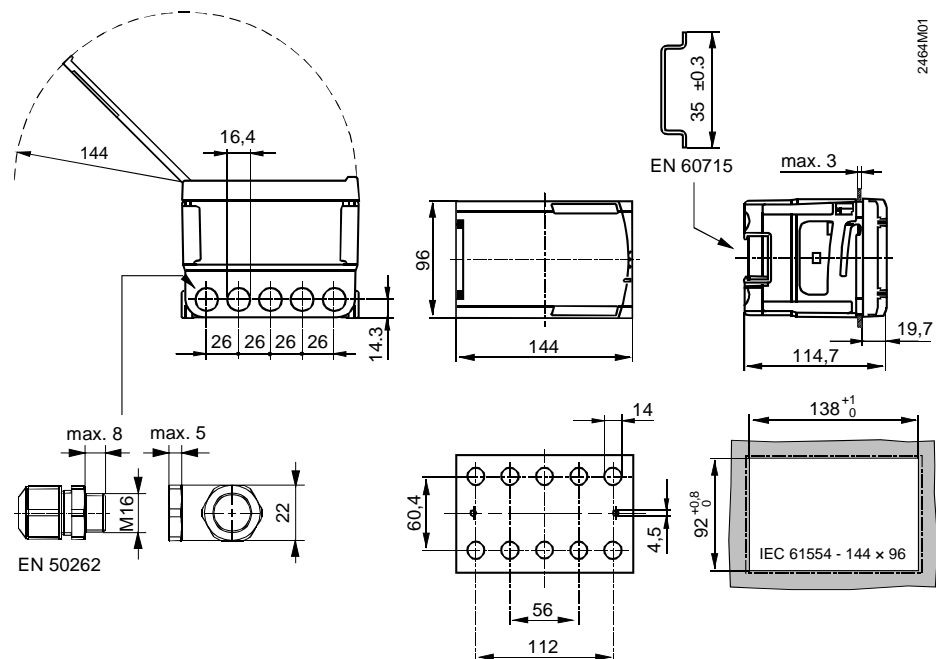

Dimensions in mm

For more detailed information about the RVP201/211, refer to the Basic Documentation P2464.

©2007 Siemens Switzerland Ltd
Subject to alteration